



---

## SUMMARY

<b>Hardware Technical Specifications .....</b>	<b>3</b>
<b>Dimension of the interface .....</b>	<b>4</b>
Front face .....	4
Top face .....	4
<b>General pinout and device's connector.....</b>	<b>5</b>
External triggers operation.....	5
USB (Yellow) LED Operation.....	6
DMX (RED) LED Operation.....	6
<b>Interfaces Master/Slave connection .....</b>	<b>7</b>
Setting of the Master/Slave interfaces .....	8
<b>Infra-Red module connections (Optional).....</b>	<b>9</b>
<b>IR REMOTE CONTROL unit and IR receiver (Optional).....</b>	<b>10</b>
<b>DMX IN trigger connection .....</b>	<b>11</b>
<b>Dmx merging in standalone .....</b>	<b>12</b>
<b>Triggers configuration with the software.....</b>	<b>13</b>
Switch to Standalone mode .....	13
External contact triggers .....	13
Infra-red remote triggers.....	14
RS232 Triggers .....	14
DMX IN triggers via another DMX signal in standalone.....	16
Time triggers with clock and calendar .....	17
Save and recover the last scene after the power cut off: .....	19
Scene trigger priorities:.....	19

## HARDWARE TECHNICAL SPECIFICATIONS

<b>Input/Output Connectors:</b>	Screw terminal (3*9 + 6 pins), Mini USB 2.0
<b>External triggers:</b>	x15 contacts (5V.) (20m max cable length)
<b>Type of Case :</b>	DIN, compatible Din rail
<b>Master/Slave connection:</b>	Yes 3 wires for 32connected interfaces max (20m max cable length)
<b>Infra-Red connection:</b>	Yes via an external IR module and 3 connection wires (15m away max )
<b>RS232 connection:</b>	Yes can receipt and send 16 characters max via the RS232 Protocol
<b>Light Sensor:</b>	Yes 3 wires (15m away max)
<b>Number of DMX Outputs:</b>	2 x 512 (PC + Stand Alone)
<b>DMX Speed:</b>	1 to 45 Hz, MaB, Bk
<b>Stand Alone Mode:</b>	Yes
<b>Internal Clock (RTC):</b>	Yes
<b>Internal calendar:</b>	Yes
<b>Backups of the internal clock:</b>	Yes, 4 weeks without power (Internal rechargeable battery)
<b>Internal memory:</b>	Yes (4 MB)
<b>Memory Capacity:</b>	5000 steps with 512 channels, 100 000 steps with 16 channels
<b>Power Input:</b>	5V to 24V DC, 0.5A max on DV connectors, 5V, 0.5A via USB
<b>Input Current:</b>	200 mA
<b>Power / Consumption:</b>	0.3 to 0.5W
<b>Contact Input Voltage (stand-alone)</b>	Contacts 3.3V~5 V DC
<b>DMX Isolation :</b>	Fuse and diode 3000V
<b>Dimensions:</b>	H: 107 mm, W: 96 mm, D: 59 mm (pcb: 102/86/19)
<b>Weight:</b>	0.17 Kgs
<b>Package total weight</b>	0.37 Kgs
<b>Color:</b>	Beige
<b>Operating temperatures:</b>	-25 to +70 °C
<b>Certificates:</b>	CE, RoHS
<b>IP Rating:</b>	IP20
<b>Place of Use:</b>	Indoor
<b>Storage:</b>	Keep in a dry place
<b>Warranty:</b>	36 months
<b>Compatibility:</b>	8 and 16 bit DMX fixtures
<b>System Compatibility:</b>	Windows XP, Vista, 7, 8, 8.1, 10, MAC OS X (10.6 and higher), Linux

## DIMENSION OF THE INTERFACE

The metric system is used. The unit is mm

### FRONT FACE

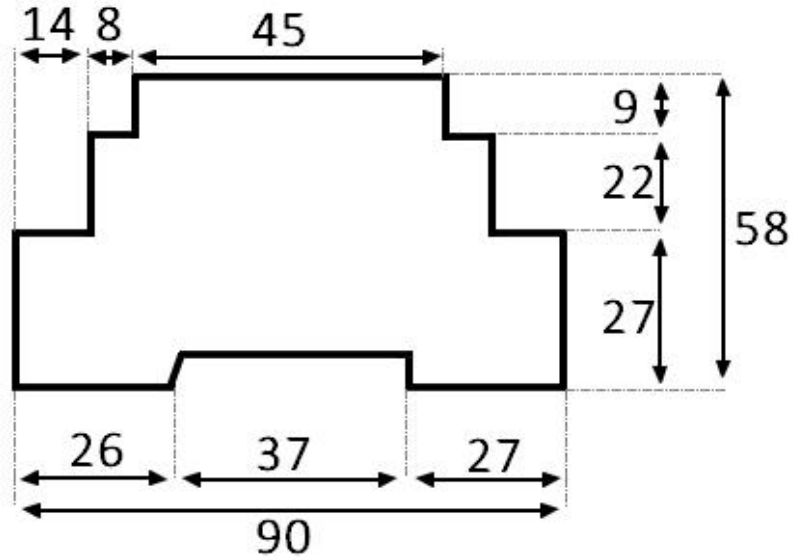

### TOP FACE

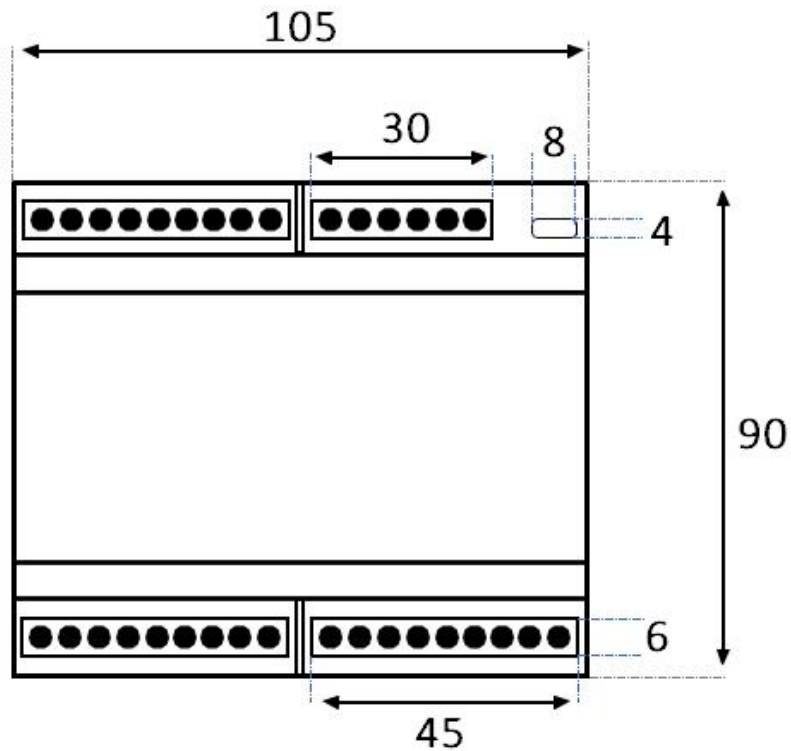

## GENERAL PINOUT AND DEVICE'S CONNECTOR

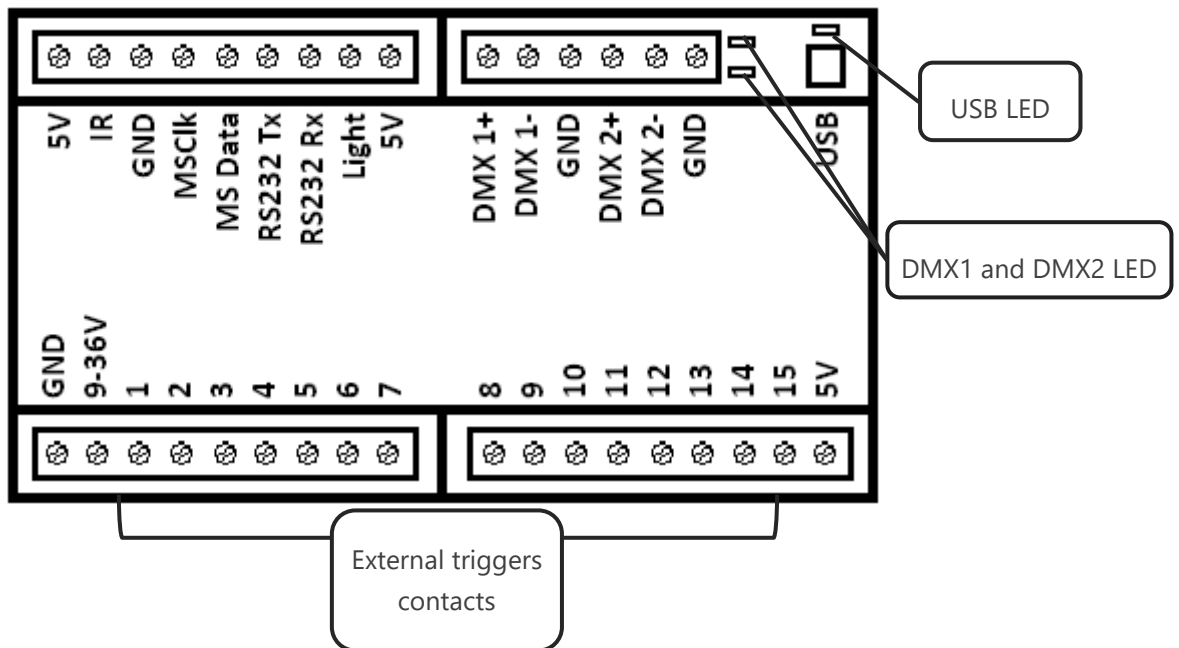

## EXTERNAL TRIGGERS OPERATION

It is possible to use 15 external contacts.

You have to connect contacts's Pin (here 1 and 2) to 5V to trigger a scene.

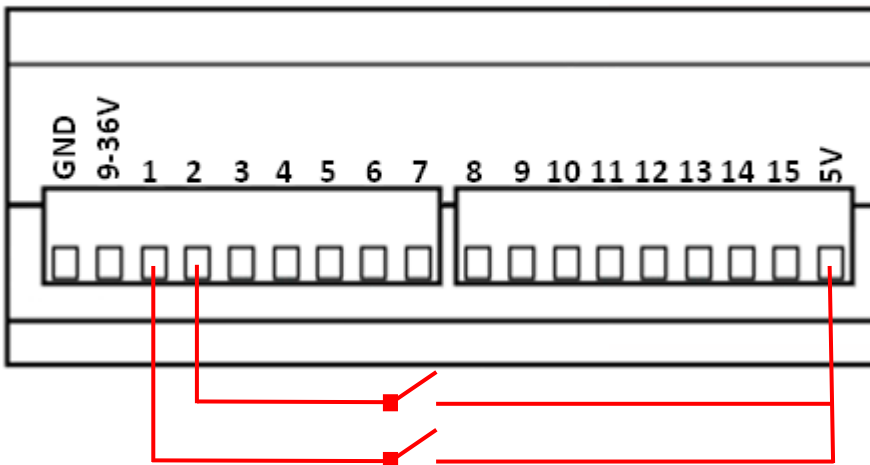

Dry contact reaction time : 5 ms (0.005 s) / Time between 2 contacts : 500 ms (0.5 s)

Dry contact trigger options : On (Start scene only) + On/Off (start and stop scene) + Auto release (Hold contact to play scenes) + Restart (restart scene from beginning) + Play in priority (Scene keep playing until it pause or stop, no other triggers allowed while playing).

## USB (YELLOW) LED OPERATION

**OFF:** Interface is not powered (check the power) or have a problem.

**Normal Blinking:** USB communication with software is active.

**Slow Blinking :** Interface is in stand alone mode.

## DMX (RED) LED OPERATION

**OFF:** No DMX signal on the line.

**ON:** DMX signal is active and send on the DMX line.

**Blinking:** DMX signal speed is slower.

## INTERFACES MASTER/SLAVE CONNECTION

Master/Slave mode allows to synchronize scenes and trigger actions of several interfaces together.

To use interfaces as Master/Slave, you have to connect the interfaces each others from the screw terminals. You need to connect together the pins M/S Data, M/S CLK and GND, as following:

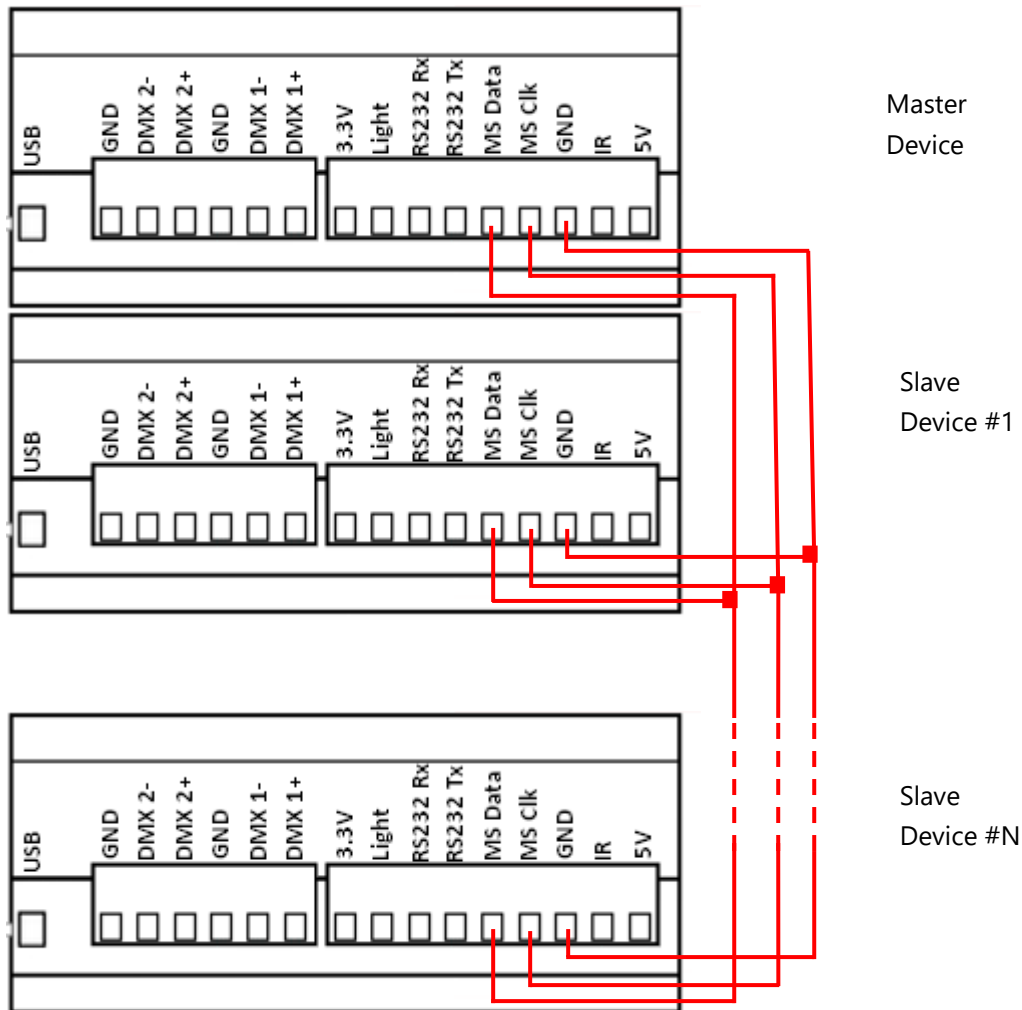

Interfaces configured as slave will strictly follow the clock, triggers and information providing by the master interface. Only one master interface at a time is possible.

## SETTING OF THE MASTER/SLAVE INTERFACES

When multiple interfaces are connected with USB, the standalone mode allows to set them as Master/Slave. This mode allows to synchronize many interfaces and mutualize their standalone spaces combining the universes. (Up to 32 standalone universes)



The Stand Alone mode allows to choose 1 interface and to define this interface as Master from the interface list, it is possible to choose only one to be the Master, all the other one will be configured as slave by default. The interfaces are always ordered by serial number ascending order.

- **MODE MASTER/SLAVE « Default »**

A single interface can be define as master (lower serial number by default), others ones are automatically set to slaves. The master device play the current scene and synchronize the slave ones. The master forces the slave interfaces to play the same scene and the same step at the same time. The slave interfaces are forced to follow the master timings and triggers and they cannot act, play or trigger a scene independently. Master can trigger on and trigger off scenes of the slave interfaces.

- **MODE MASTER/SLAVE « Desynchronized»**

An interface can be define as master, others are automatically set to slaves. All Triggers On or Off operated on the master interface are effective to slave ones. However slave interfaces are not synchronized with master's timing and keep individual controls. Consequently slaves can trigger and play different scenes at any time and not synchronized with the master ones. The master acts like a general remote imposing triggering to the slaves with total priority. Master can trigger ON and trigger OFF scenes of the slave interface.

- **MODE MASTER/SLAVE « LTP »**

LTP means Latest Takes Priority. All interfaces are defined as slaves. Interfaces are not synchronized with timing and can trigger and play different scenes by itself. However triggers from an interface are passed to the others connected interfaces automatically and slave interfaces are forced to trigger the same scene. Here each interface acts like a general remote imposing triggering to the other slaves without synchronization.



- **THE «NO RELEASE» Option**

This option is only available with LTP or DESYNCHRONIZED modes. Only triggers ON from the master interface are executed and effective. All triggers OFF are ignored and slaves interfaces keep playing their current scene. Each Slave interface can choose to release or not its scene depend on the option is activated or not.

## INFRA-RED MODULE CONNECTIONS (OPTIONAL)

An external Infra-Red module is required. It connects as following:  
GND (pin 1 or 10) + 5V. DC out (pin 2) + IR Signal (pin 11).

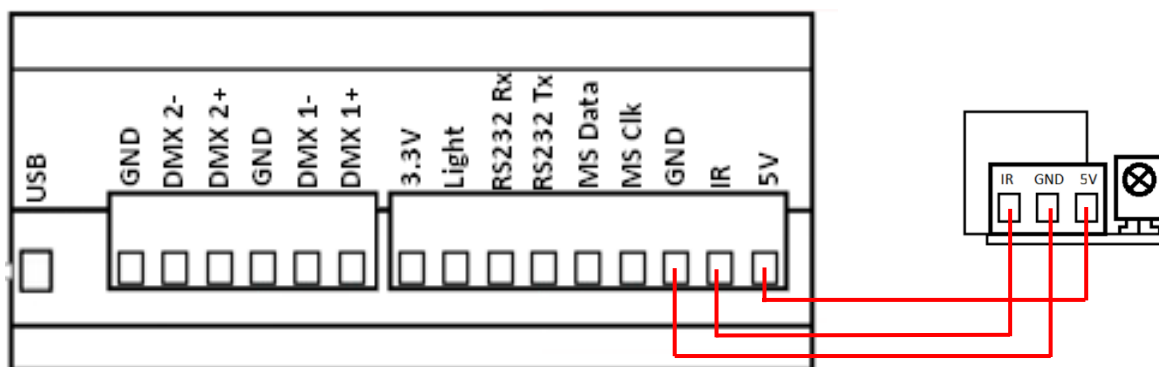

## IR REMOTE CONTROL UNIT AND IR RECEIVER (OPTIONAL)

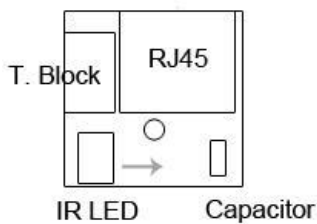
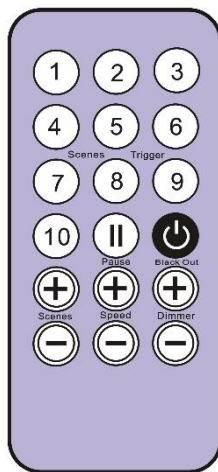

Button 1 to 10 must be assigned to a scene via the software.

Each button can trigger a different scene. With the remote control, a scene cannot be stop directly with the assigned button. To stop it you must press the Stop/Black Out button or trigger another scene.

**Pause button** to freeze the current scene to its actual state.

**Stop/Black Out** button to stop the current scene and play the empty scene number 00. All DMX channels are set down to 00 levels.

**+/- for scene trigger.** Select the next or previous scene automatically. You don't need to hold the button to validate and play a scene. The next or previous scene will play directly after selected.

**+/- for Scene speed.** Increase or decrease the speed of the current scene. A different speed can be chosen separately for each scene.

**+/- for General dimmer.** Increase or decrease the RGB, CMY and dimmer channels of the fixtures. The CMY, RGB, Dimmer channels are defined in the Profile of the fixture.

To use the IR remote control, an external PCB with an IR receiver LED must be connected before to the RJ45 #1 of the Stand Alone interface. The standard RJ45 cable distance is about 20 meters maximum.

### IR PCB Pin assignment:

-With RJ45: use Pins **#3**=Ground; Pin **#4** = IR Data ; Pin **#7** = 5V DC

-With T. Block: use Pins **O** = IR Data ; **V** = 5V DC ; **G** = Ground.

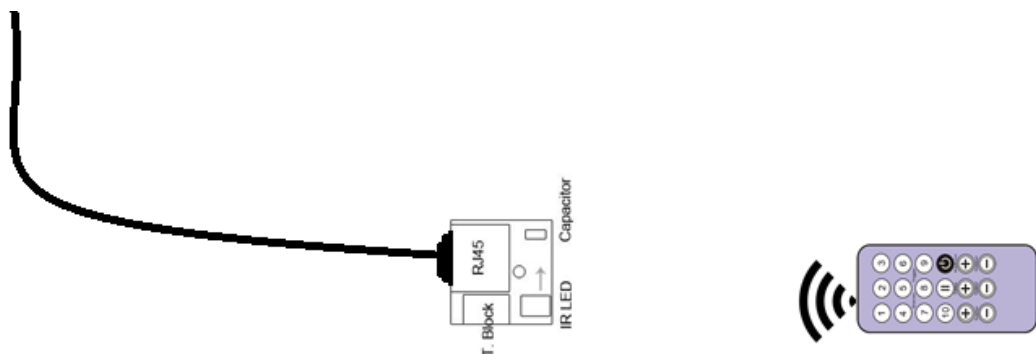

# DMX IN TRIGGER CONNECTION

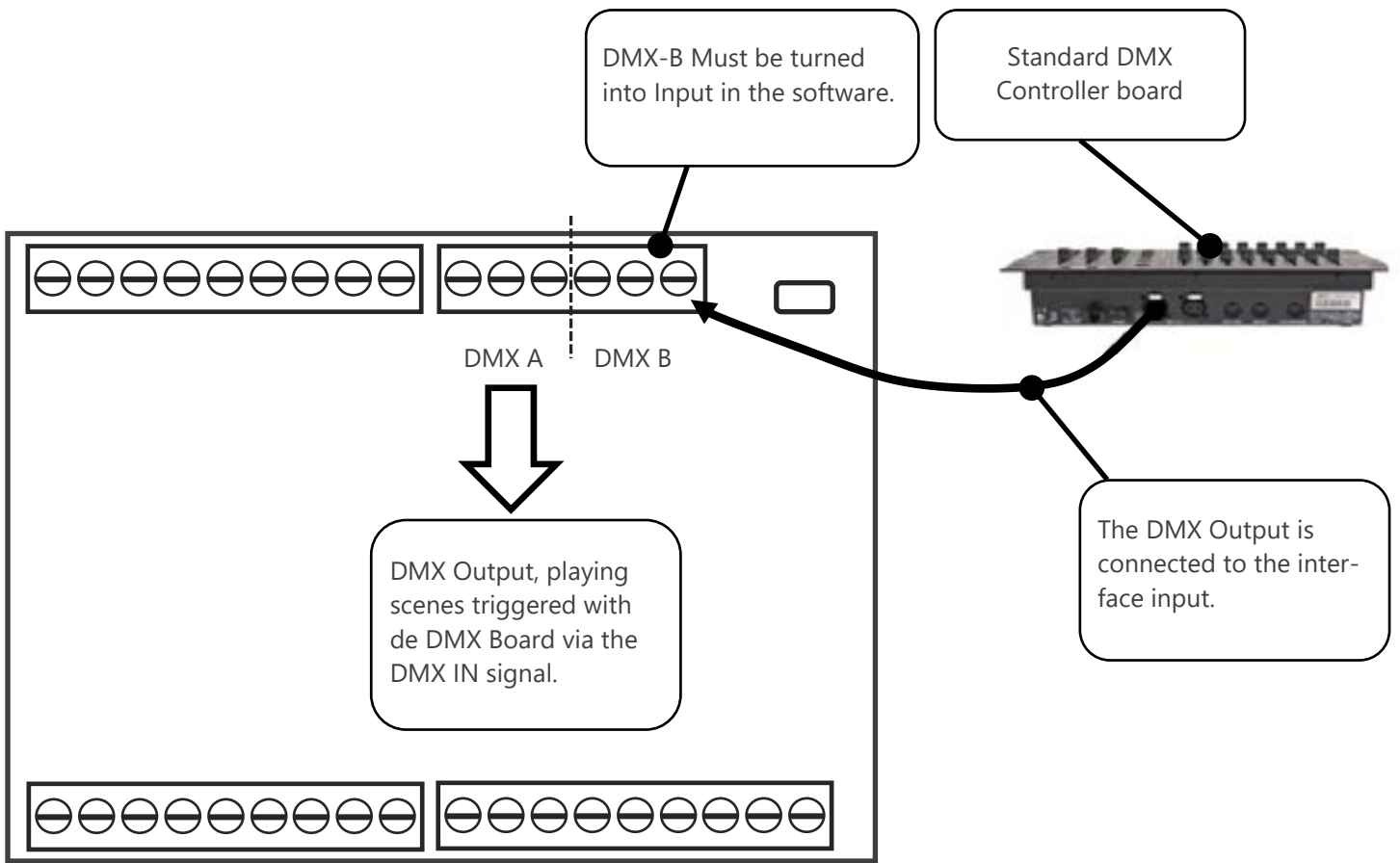

## DMX MERGING IN STANDALONE

DMX Merging is available for the DIN interfaces because it takes two DMX lines to make a merge.

One DMX line must be turned into an input to capture the dmxd signal provided by an external DMX board or by another DMX interface.

The interface will merge the input signal with its own output signal by comparing DMX levels with a HTP filter. Merging is a solution to keep manual control on channels, using a DMX Board for example. It's also a way to create a multi-zones system by merging several interfaces on one final DMX line.

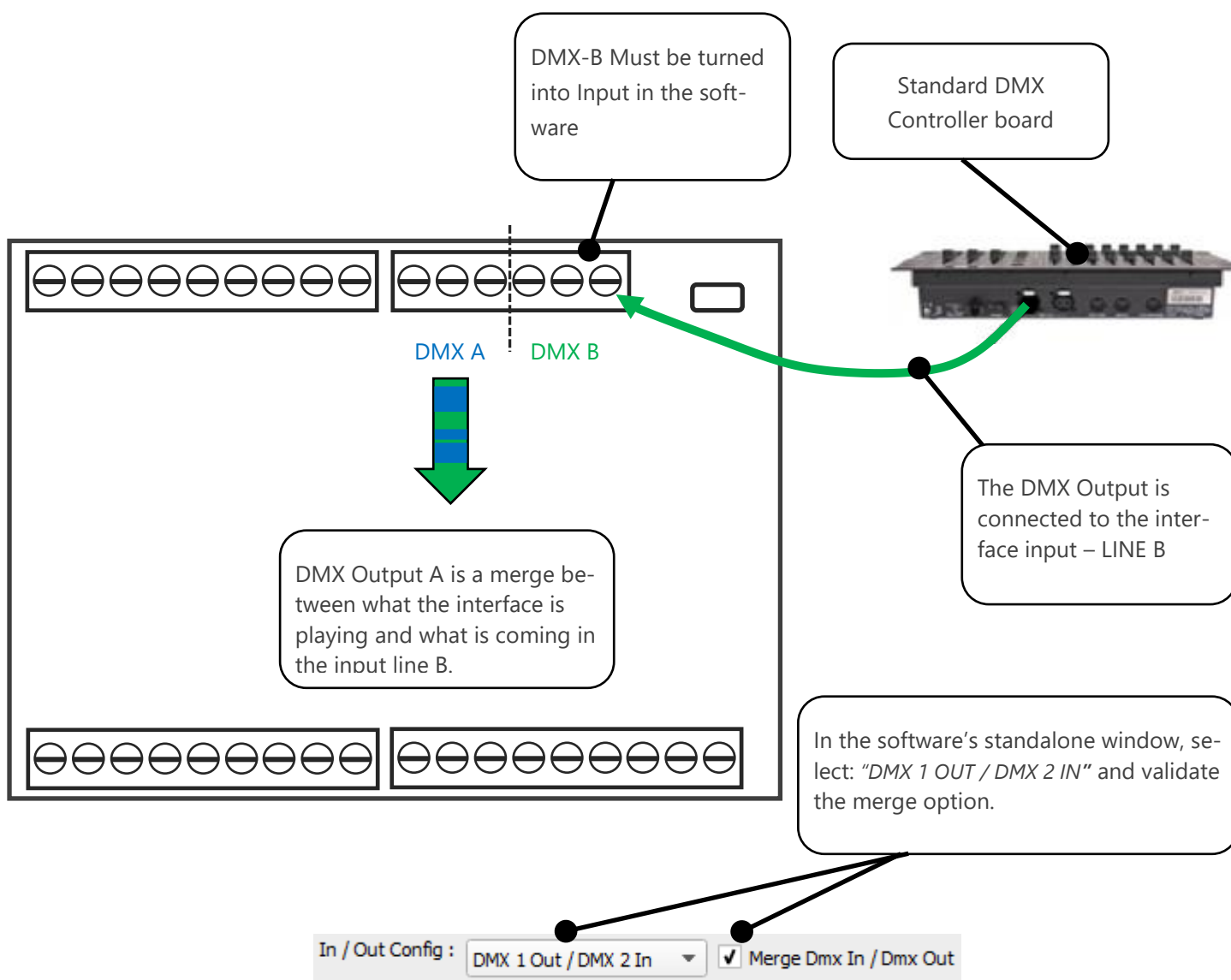

## TRIGGERS CONFIGURATION WITH THE SOFTWARE

The Stand Alone mode of the software enables to configure and personalize all the triggers.

The information will be directly saved in the DMX interface memory with the memory writing function.

### SWITCH TO STANDALONE MODE

When the device isn't connected to the software or has just been powered, it enters in Stand Alone mode after five (5) seconds.

### EXTERNAL CONTACT TRIGGERS

The Stand Alone mode offers up to 15 external triggers.

By selecting a scene in the list, it's possible to choose the external contact number (from 01 to 15) to trigger the scene.

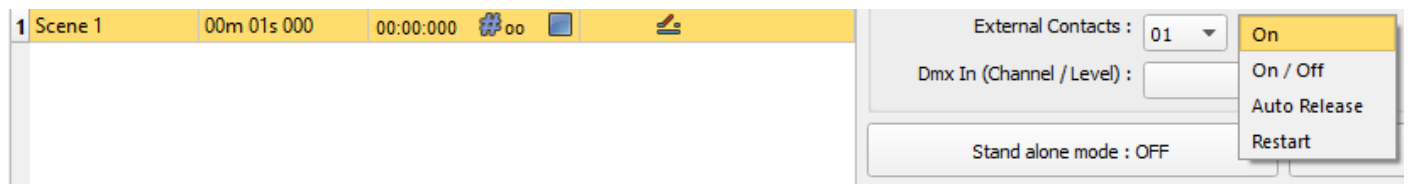

Several trigger options are available for externals contacts triggers:

**On** : Activate the contact only allow you to play the scene.

**On/Off** : Activate the contact allow you to play and stop a scene. Each trigger action will invert the state of the scene (start/stop).

**Auto Release**: The scene plays while the contact is activated. Keep the contact activated to play the scene, when the contact is released the scene stop.

**Restart** : Activate the contact restart the scene from its beginning, if the scene is of, then it start to play. Activate the contact will restart the scene from its beginning automatically. If the scene is off already, then it will play.

## INFRA-RED REMOTE TRIGGERS

Standalone mode offers up to 10 triggers with the Infrared remote. By selecting a scene in the list, it's possible to choose the remote button number (from 01 to 10) to trigger the scene. The other IR remote functions will work as well as the SLIM DMX interface. (Speed, dimmer, scene +, scene -, off).



## RS232 TRIGGERS IN STAND ALONE

Standalone mode allows to use the RS232 protocol to control the DMX interface with the commands describe in the help topic 

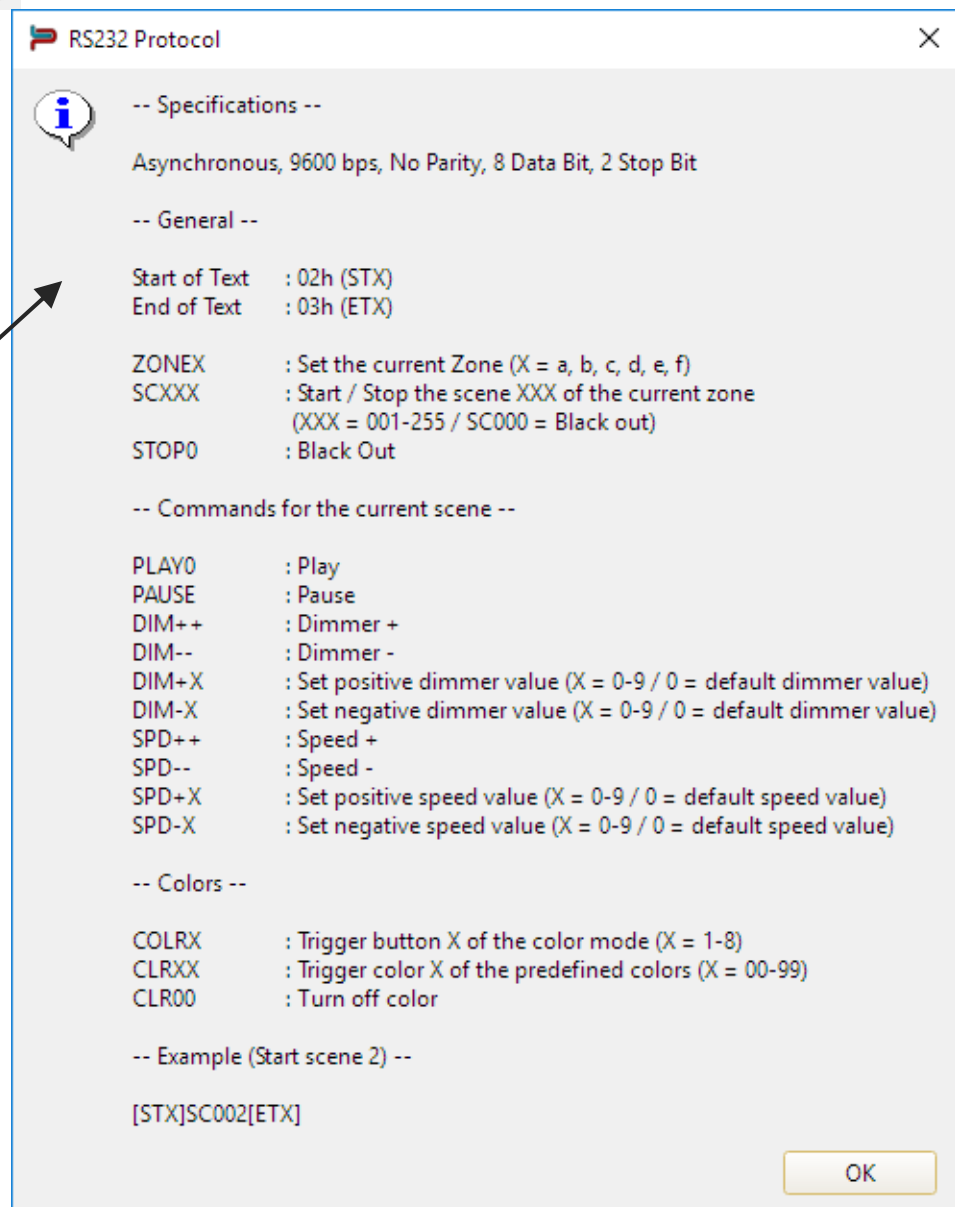
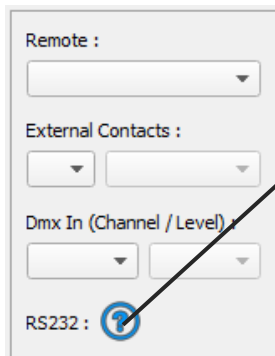

**RS232 Protocol**

 -- Specifications --  
Asynchronous, 9600 bps, No Parity, 8 Data Bit, 2 Stop Bit

-- General --

Start of Text : 02h (STX)  
End of Text : 03h (ETX)

ZONEX : Set the current Zone (X = a, b, c, d, e, f)  
SCXXX : Start / Stop the scene XXX of the current zone  
(XXX = 001-255 / SC000 = Black out)  
STOP0 : Black Out

-- Commands for the current scene --

PLAY0 : Play  
PAUSE : Pause  
DIM++ : Dimmer +  
DIM-- : Dimmer -  
DIM+X : Set positive dimmer value (X = 0-9 / 0 = default dimmer value)  
DIM-X : Set negative dimmer value (X = 0-9 / 0 = default dimmer value)  
SPD++ : Speed +  
SPD-- : Speed -  
SPD+X : Set positive speed value (X = 0-9 / 0 = default speed value)  
SPD-X : Set negative speed value (X = 0-9 / 0 = default speed value)

-- Colors --

COLRX : Trigger button X of the color mode (X = 1-8)  
CLRXX : Trigger color X of the predefined colors (X = 00-99)  
CLR00 : Turn off color

-- Example (Start scene 2) --

[STX]SC002[ETX]

OK

Connect the RS232 transmitter to the interface RS232 and GND pins and send the dedicated ASCII commands lines that you need.

The ASCII commands need to be send one time only to be processed by the interface.

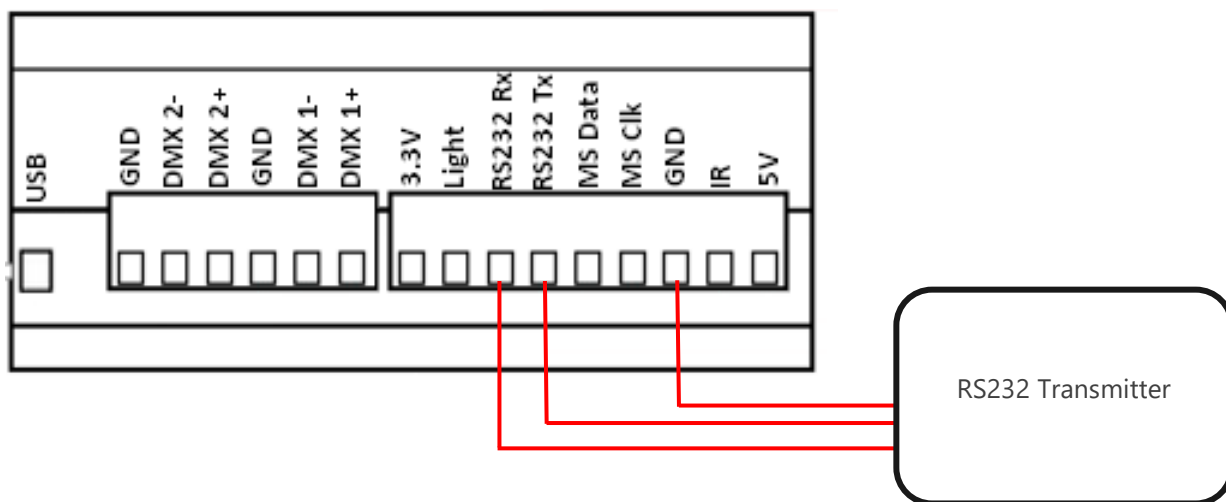

# ASCII TABLE

Decimal	Hexadecimal	Binary	Octal	Char	Decimal	Hexadecimal	Binary	Octal	Char	Decimal	Hexadecimal	Binary	Octal	Char
0	0	0	0	[NULL]	48	30	110000	60	0	96	60	1100000	140	`
1	1	1	1	[START OF HEADING]	49	31	110001	61	1	97	61	1100001	141	a
2	2	10	2	[START OF TEXT]	50	32	110010	62	2	98	62	1100010	142	b
3	3	11	3	[END OF TEXT]	51	33	110011	63	3	99	63	1100011	143	c
4	4	100	4	[END OF TRANSMISSION]	52	34	110100	64	4	100	64	1100100	144	d
5	5	101	5	[ENQUIRY]	53	35	110101	65	5	101	65	1100101	145	e
6	6	110	6	[ACKNOWLEDGE]	54	36	110110	66	6	102	66	1100110	146	f
7	7	111	7	[BELL]	55	37	110111	67	7	103	67	1100111	147	g
8	8	1000	10	[BACKSPACE]	56	38	111000	70	8	104	68	1101000	150	h
9	9	1001	11	[HORIZONTAL TAB]	57	39	111001	71	9	105	69	1101001	151	i
10	A	1010	12	[LINE FEED]	58	3A	111010	72	:	106	6A	1101010	152	j
11	B	1011	13	[VERTICAL TAB]	59	3B	111011	73	;	107	6B	1101011	153	k
12	C	1100	14	[FORM FEED]	60	3C	111100	74	<	108	6C	1101100	154	l
13	D	1101	15	[CARRIAGE RETURN]	61	3D	111101	75	=	109	6D	1101101	155	m
14	E	1110	16	[SHIFT OUT]	62	3E	111110	76	>	110	6E	1101110	156	n
15	F	1111	17	[SHIFT IN]	63	3F	111111	77	?	111	6F	1101111	157	o
16	10	10000	20	[DATA LINK ESCAPE]	64	40	1000000	100	@	112	70	1110000	160	p
17	11	10001	21	[DEVICE CONTROL 1]	65	41	1000001	101	A	113	71	1110001	161	q
18	12	10010	22	[DEVICE CONTROL 2]	66	42	1000010	102	B	114	72	1110010	162	r
19	13	10011	23	[DEVICE CONTROL 3]	67	43	1000011	103	C	115	73	1110011	163	s
20	14	10100	24	[DEVICE CONTROL 4]	68	44	1000100	104	D	116	74	1110100	164	t
21	15	10101	25	[NEGATIVE ACKNOWLEDGE]	69	45	1000101	105	E	117	75	1110101	165	u
22	16	10110	26	[SYNCHRONOUS IDLE]	70	46	1000110	106	F	118	76	1110110	166	v
23	17	10111	27	[ENG OF TRANS. BLOCK]	71	47	1000111	107	G	119	77	1110111	167	w
24	18	11000	30	[CANCEL]	72	48	1001000	110	H	120	78	1111000	170	x
25	19	11001	31	[END OF MEDIUM]	73	49	1001001	111	I	121	79	1111001	171	y
26	1A	11010	32	[SUBSTITUTE]	74	4A	1001010	112	J	122	7A	1111010	172	z
27	1B	11011	33	[ESCAPE]	75	4B	1001011	113	K	123	7B	1111011	173	{
28	1C	11100	34	[FILE SEPARATOR]	76	4C	1001100	114	L	124	7C	1111100	174	
29	1D	11101	35	[GROUP SEPARATOR]	77	4D	1001101	115	M	125	7D	1111101	175	}
30	1E	11110	36	[RECORD SEPARATOR]	78	4E	1001110	116	N	126	7E	1111110	176	~
31	1F	11111	37	[UNIT SEPARATOR]	79	4F	1001111	117	O	127	7F	1111111	177	[DEL]
32	20	100000	40	[SPACE]	80	50	1010000	120	P					
33	21	100001	41	!	81	51	1010001	121	Q					
34	22	100010	42	"	82	52	1010010	122	R					
35	23	100011	43	#	83	53	1010011	123	S					
36	24	100100	44	\$	84	54	1010100	124	T					
37	25	100101	45	%	85	55	1010101	125	U					
38	26	100110	46	&	86	56	1010110	126	V					
39	27	100111	47	'	87	57	1010111	127	W					
40	28	101000	50	(	88	58	1011000	130	X					
41	29	101001	51	)	89	59	1011001	131	Y					
42	2A	101010	52	*	90	5A	1011010	132	Z					
43	2B	101011	53	+	91	5B	1011011	133	[					
44	2C	101100	54	,	92	5C	1011100	134	\					
45	2D	101101	55	-	93	5D	1011101	135	]					
46	2E	101110	56	.	94	5E	1011110	136	^					
47	2F	101111	57	/	95	5F	1011111	137	_					

## DMX IN TRIGGERS VIA ANOTHER DMX SIGNAL IN STANDALONE

The Stand Alone mode offers up to 512 DMX IN channel triggers and up to 255 DMX trigger values per channel. By selecting a scene in the list, it's possible to choose the channel number and the DMX value to trigger the scene. The scene will play when the value of the DMX channel is reached or exceeded.



One DMX Output must be turned into an input in the Options windows. To access this window click on the software menu: Tools > Options then click to select the device section as following:

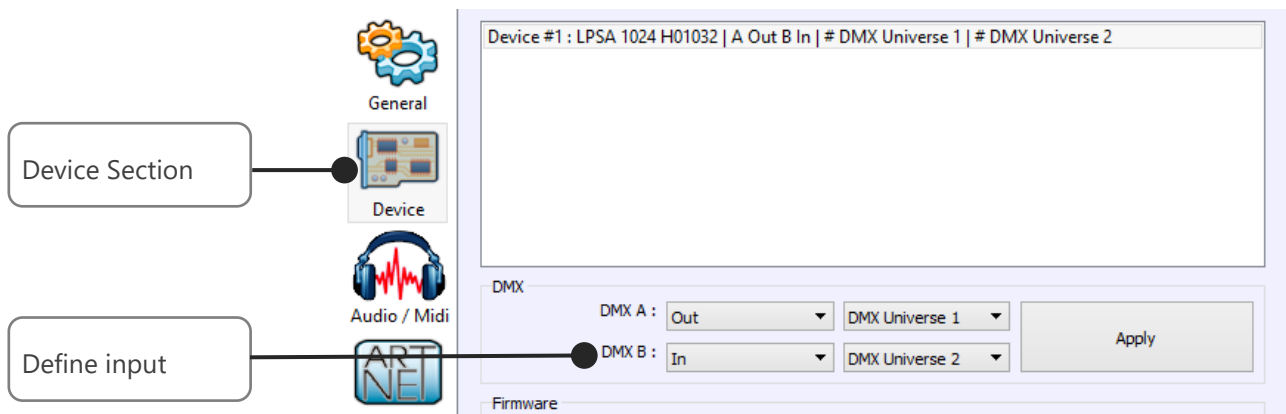



## TIME TRIGGERS WITH CLOCK AND CALENDAR

The Stand Alone mode has an internal clock and a calendar. It's possible to assign a time trigger on every scene of the list. By selecting a scene on the list, it's possible to choose the start and end dates and hours and days of the week. You can thus create a lot of scenarios.

### CASE 1: Programming a unique trigger:

- **Start schedule:**

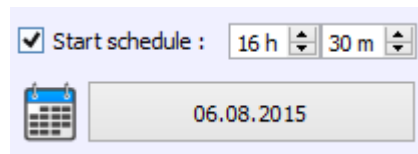

The scene is triggered a single time at the given date and time.

- **End schedule:**

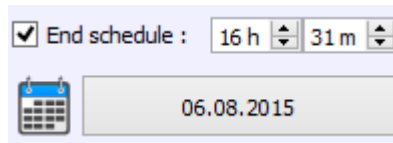

The scene is stopped at the given date and time.

### CASE 2: Programming a repeating trigger:

- **Start schedule:**

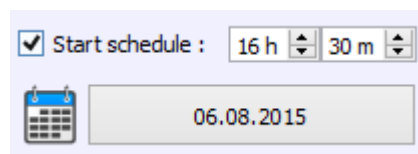

Date from which-one the scene will be playable according to the programmed triggers

- **End schedule:**

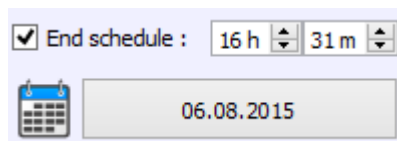

Date after witch-one triggers will be ignored. With no End date, triggers are permanent

- **List of the months of the year**

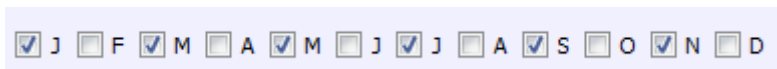

The 12 check boxes represents the 12 months of the year (J) January to (D) December. The triggers will be performed on the activated months. Next, a daily hours range must be defined.

- **Start and Stop days**



With a monthly repetition, you can choose the starting and stopping days for each chosen month. In this example triggers can happen between the 1<sup>st</sup> and the 15<sup>th</sup> of each chosen month.

- **List of the days of the week**

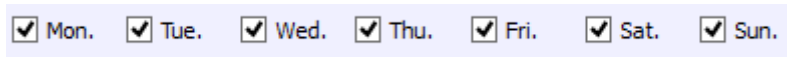

The 7 check boxes represents the 7 days in a week. The triggers will be performed on the activated days only. Next, a time range must be defined.

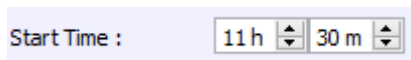

- **Start time**

The starting time is the time when the scene will be triggered for each chosen day. Of course chosen months, start and end schedule days are included.

- **Release time**

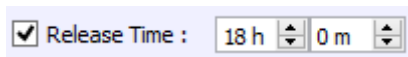

The release time is the time when the scene will stop for each chosen day. Of course chosen months, start and end schedule days are included. The release time is not mandatory, if it's not defined, the scene will keep playing until another trigger event happens. (Like the triggering of another scene for example).

**NOTE:** For a daily repetition, if the the starting time is later than the release time then the triggering will stopped the next day, even if the next day has not been selected.

## SAVE AND RECOVER THE LAST SCENE AFTER THE POWER CUT OFF:

Scenes with a start schedule and a stop schedule are set on a defined time space and can be memorized. The interface save the last scene played before the power cut off and recover it when the power is restored. The scene must obligatory include a start schedule and a stop schedule activate this option.

## SCENE TRIGGER PRIORITIES:

When several scenes have the same time trigger (date + hour + minute), only the first scene in the list will be triggered. The rest will be ignored